

# AL14

## BRACCIO TELESCOPICO

GENERATION

**S**

+

PARTI IN FUSIONE PER LE  
PARTI SOTTOPOSTE  
AD ELEVATE  
SOLLECITAZIONI

+

ACCIAI AD ALTA  
RESISTENZA

+

SICUREZZE INTEGRATE  
CHE LIMITANO LE  
MANOVRE PERICOLOSE  
O ERRATE

+

CILINDRI  
IDRAULICI DI  
FABBRICAZIONE  
MARREL



### PUNTI FORTI

- > **GANCIO SMONTABILE**  
o con linguetta di sicurezza
- > **TELAIO DI POTENZA  
BASCULANTE**  
Marrel garantisce una potenza  
senza eguali
- > **SABBIATURA E VERNICIATURA**  
prima dell'assemblaggio
- > **PERSONALIZZAZIONE:**  
Colore su richiesta e ampia gamma  
di accessori
- > **ALTEZZA TELAIO RIDOTTA**
- > **AMMORTIZZATORE DI  
FINECORSA INTEGRATO**  
nei cilindri del braccio

**AMPLIROLL® HIGH**

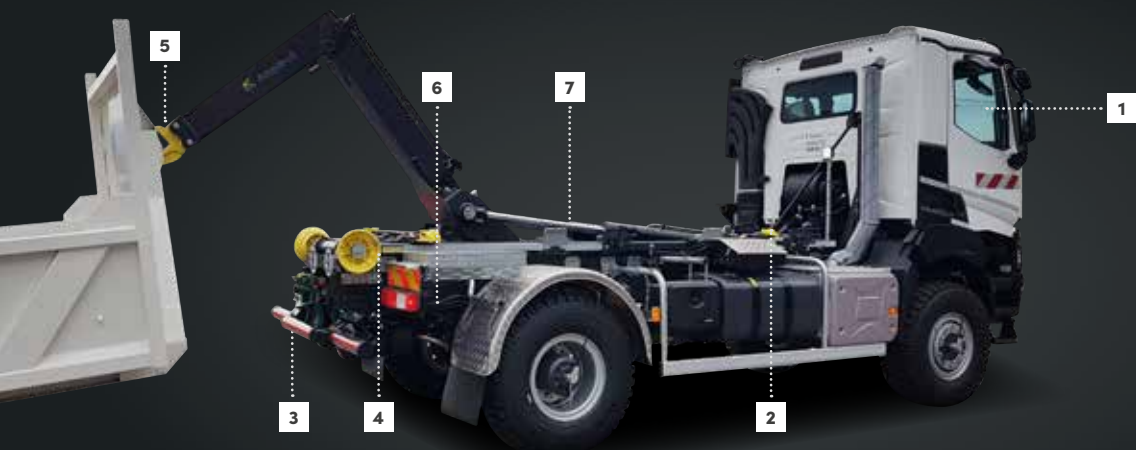













### LE OPZIONI

- |          |   |   |          |   |  |          |  |   |
|----------|---|---|----------|---|--|----------|--|---|
| <b>1</b> |    | Comandi disponibili:<br>Elettrico,<br>radiocomandato                        | <b>2</b> |  | Chiusura idraulica<br>anteriore                                      | <b>3</b> |  | Barra di<br>Protezione<br>Paraincastro<br>PANTO, ribaltabile<br>o fissa |
| <b>4</b> |    | Derivazioni<br>idrauliche (gru<br>- rimorchi con<br>cassone,...)            | <b>5</b> |  | Gancio con<br>linguetta di<br>sicurezza<br>meccanica o<br>pneumatica | <b>6</b> |  | Stabilizzazione<br>del veicolo con<br>dispositivi di<br>sicurezza       |
| <b>7</b> |  | Piastre di<br>fissaggio<br>specifiche per i<br>differenti tipi di<br>telaio |          |   |  |          |  |   |

Altre opzioni disponibili per una configurazione personalizzata

FICHEPRODUIT/AL14/042021/200IT — ohi.studio (fr)

Per telai PTT da 15 a 19 T		S40	S41	S42	S43	S44	S45	S46	S47	S48	S49	S50	S51	S52
	Min.	3 700	3 700	3 700	3 700	4 000	3 700	4 000	4 000	4 000	4 000	4 100	4 300	4 300
	Max.	5 100	5 200	5 300	5 400	5 500	5 600	5 700	5 800	5 900	6 000	6 100	6 200	6 300
	B.P. Fissa	4 500	4 600	4 700	4 800	4 900	5 000	5 100	5 200	5 300	5 400	5 500	5 600	5 700
	A°	52	52	52	52	58	52	58	58	58	58	58	58	58
	L1	4 000	4 100	4 200	4 300	4 400	4 500	4 600	4 700	4 800	4 900	5 000	5 100	5 200
	L2	630	730	830	930	730	1 130	930	1 030	1 130	1 230	1 230	1 130	1 230
	H	255	255	255	255	255	255	255	255	255	255	255	255	255
	Kg	1 650	1 650	1 675	1 675	1 700	1 700	1 725	1 750	1 750	1 750	1 750	1 950	1 950
	Bar	270	270	270	270	295	270	295	295	295	295	310	300	300

Per telai PTT da 15 a 19 T		S53	S54	S55	S56	S57	S58
	Min.	4 400	4 600	4 600	4 600	4 600	4 600
	Max.	6 400	6 500	6 700	6 800	6 900	7 000
	B.P. Fissa	5 800	5 900	6 000	6 100	6 200	6 300
	A°	58	58	58	58	58	58
	L1	5 300	5 400	5 500	5 600	5 700	5 800
	L2	1 230	1 130	1 230	1 330	1 430	1 530
	H	255	255	255	255	255	255
	Kg	1 950	2 075	2 090	2 095	2 095	2 100
	Bar	300	320	320	320	320	320

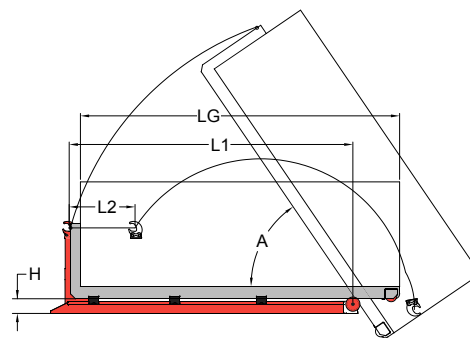

Con riserva di modifiche tecniche, dati non contrattuali

+33 (0)4 77 36 28 28  
42 avenue de Saint-Étienne – BP70056  
42161 Andrézieux-Bouthéon cedex  
FRANCE

 @marrelsas

  
**MARREL**  
FASSI GROUP