

AL4

BRACCIO TELESCOPICO



+ ALTEZZA GANCIO
STANDARDIZZATA

+ ADATTABILE
A QUALSIASI TIPO
DI CASSONE

+ CILINDRI IDRAULICI
DI FABBRICAZIONE
MARREL

+ SICUREZZE
INTEGRATE CHE
LIMITANO LE MANOVRE
PERICOLOSE O ERRATE

+ GRANDE
PROFONDITÀ
DI GAMMA



PUNTI FORTI

- > ALTEZZA DELL'APPARECCHIO OTTIMIZZATA
- > PESO OTTIMIZZATO per un carico utile massimo
- > COMANDO RIMOVIBILE E CALAMITATO con schermo digitale
- > SABBIAIATURA E VERNICIATURA PRIMA DEL MONTAGGIO
- > PERSONALIZZAZIONE: colore su richiesta e ampia gamma di accessori
- > ADATTABILITÀ A QUALSIASI TIPO DI TELAIO

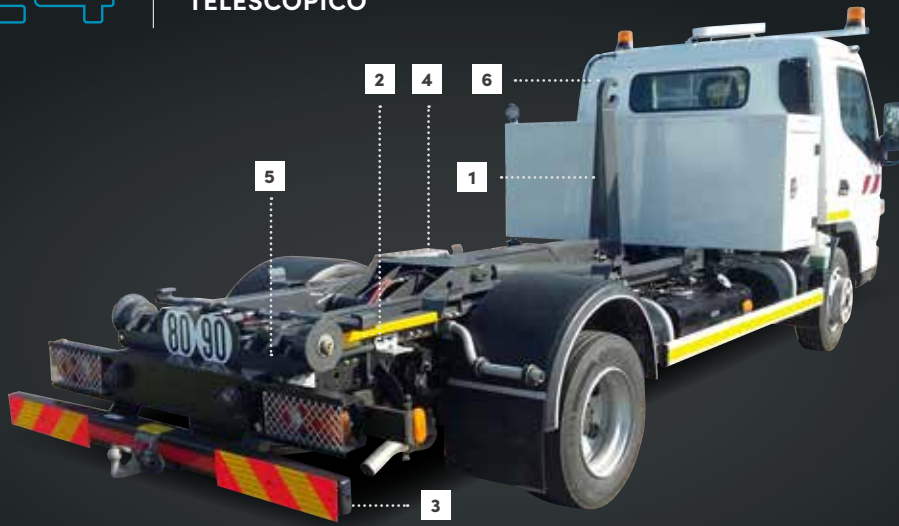

LE OPZIONI

1  Differenti altezze del gancio a partire da 920mm a 1570mm

2  Piastre di fissaggio specifiche per i differenti tipi di telaio

3  Barra di Protezione Paraincastro estensibile







4  **12V**
24V Versioni 12V e 24V

5  Doppia larghezza delle piste 850 mm e 1060 mm

6  Gancio con sicurezza meccanica

Altre opzioni disponibili per una configurazione personalizzata

FICHEPRODUIT/AL4/042021/200IT — ohstudio.it

Per telai di PTT fino a 7,5 T		A26	A27	A28	A29	A30	A31	A32	A33	A34	A35	A36
	Min.	2 300	2 300	2 300	2 600	2 600	2 600	2 600	2 900	2 900	2 900	2 900
	Max. LG	3 100	3 400	3 600	3 800	3 900	4 000	4 100	4 200	4 300	4 400	4 500
	B.P. Fissa	2 800	2 900	3 000	3 100	3 200	3 300	3 400	3 500	3 600	3 700	3 800
	A°	56	56	56	56	56	56	56	53	53	53	53
	L1	2 550	2 650	2 750	2 850	2 950	3 050	3 150	3 250	3 350	3 450	3 550
	L2	550	650	750	550	650	750	850	650	750	850	950
	H	160	160	160	160	160	160	160	160	160	160	160
	Kg	605	615	625	635	645	655	665	675	685	695	705
	Bar	280	280	280	300	300	300	300	315	315	315	315

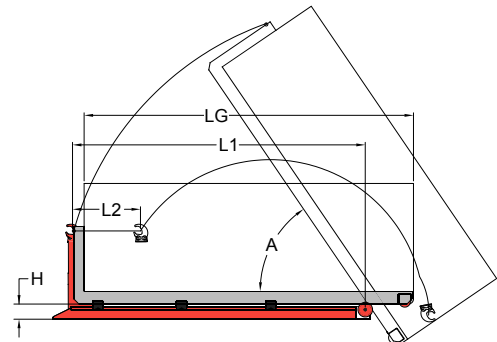

Con riserva di modifiche tecniche, dati non contrattuali

+33 (0)4 77 36 28 28
42 avenue de Saint-Étienne – BP70056
42161 Andrézieux-Bouthéon cedex
FRANCE

 @marrelsas

MARREL
FASSI GROUP